



化妆品包装容器专业制造商



[www.sprayer.com.cn](http://www.sprayer.com.cn)

宁波弗岚塑业有限公司  
NINGBO FLY PLASTIC INDUSTRY CO., LTD.  
余姚市富兰德包装有限公司  
YUYAO FRIEND PACKING CO., LTD.



浙江省宁波市余姚市马渚镇诸北西路65号  
No.65, Zhubei West Road, Mazhu Town, Yuyao, Zhejiang, China.315400



86-574-62477180 62487168 62856377



+86 13957440388 +86 13805800275



[info@sprayer.com.cn](mailto:info@sprayer.com.cn)



宁波弗岚塑业有限公司  
NINGBO FLY PLASTIC INDUSTRY CO., LTD.

余姚市富兰德包装有限公司  
YUYAO FRIEND PACKING CO., LTD.



**FRIEND PACKING**

*Professional manufacturer of  
cosmetic packaging*

## 企业简介

宁波弗岚塑业有限公司(余姚市富兰德包装有限公司)是一家专业研发生产各种手扣式喷雾器、乳液泵、小喷雾、塑料盖膏霜盒和塑料瓶等化妆品包装制品的公司。

我公司坐落在塑料王国余姚，地理位置优越，毗邻经济繁荣的宁波市海空港口。产品已经远销欧洲，美洲，中东，东南亚等几十个国家和地区，受到广大客户的广泛好评。

公司能根据客户要求设计、生产各类塑料喷雾器制品。欢迎广大客户来电咨询洽谈。我公司始终坚持以质量取胜，以服务为本的宗旨，共同发展，实现双赢。

Ningbo Fly Plastic Industry Co., Ltd. (Yuyao Friend Packing Co., Ltd.) is a manufacturer who specialized in researching, developing and producing trigger sprayer, lotion pump, mist sprayer, plastic cap, cream jar, plastic bottle and other cosmetic packages.

We are located in Yuyao city of Ningbo, with convenient transportation to airport and seaport. All of our products comply with international quality standards and are greatly appreciated in a variety of different markets throughout the world.

If you are interested in any of our products or would like to get more informations, please feel free to contact us. We are looking forward to forming successful business relationships with new clients around the world in near future.

# Welcome To Friend Packing



Focus On  
The Industry For  
More Than  
**22**  
Years



## 研发创新

# R&D



公司拥有经验丰富、技术娴熟的模型设计师，通过高效的沟通，运用国际领先的设计软件，能在第一时间把客户的想法参数化，模块化，力争在最短的时间内完成产品造形，时刻要求自己做到“追求时尚，勇于实践，敢于创新，力求完美”。

We have experienced, skilled model designers, through efficient communication, using international advanced design software, can in first time customer's idea of parameterized, modular, strive to finish in the shortest time make of product form, always ask ourselves to do "pursuit vogue, brave practice, dares to innovate, strive for perfection".

我们具备专业高效运作的研发团队，能够将绿色技术运用到日化包装领域，不断提升研发技术与品质。我们具有独到的创新理念，本着对美丽的不懈追求与向往，也于突破传统，将顾客的感受摆在首要位置，创造出让客户满意的时尚、环保、健康的产品！

We have professional and efficient operation of the R & D team, able to use green technology to the field of cosmetic packaging and improve the research and development technology and quality. We have a unique innovative ideas, in the relentless pursuit and desire of beauty, the courage to break tradition, the feelings of the customer in the forefront to create complete customer satisfaction to sell fashion, environmental protection, health products!



## 缜密检测

苛刻严谨的品质检验人员恪守产品质量标准，严格把关产品试验到生产全过程。品质检测中心对每件产品进行零故障检测，有效避免漏液、卡滞等缺陷的发生。并建立了有效的关键控制点的识别、监视和改进系统，确保产品品质达到行业的一流水平。



# Innovation Careful Detection

Harsh and rigorous quality inspectors adhere to product quality standards and strictly control product testing to the entire production process. The quality inspection center conducts zero fault detection on each product, effectively avoiding the occurrence of defects such as leakage of liquids and card-corruption. It has established an effective identification, monitoring and improvement system for key control points to ensure that the product quality meets the industry's top level.



领先设备

# Leading Equipment

先进的工艺，  
完备的专业测试设备，  
为客户提供全套的加工配套服务。

## Advanced Equipment

Complete professional testing equipment, A full set of processing supporting services.



拥有全球先进设备，多条自动化的生产线，缜密的制造工艺和完美的检测，全面实现生产智能化，严格控制产品的质量，确保标准得以实现。

With global advanced equipment, multiple automated production lines, careful manufacturing processes and perfect testing, we have fully realized production intelligence, strictly controlled the quality of our products, and ensured that standards were achieved.

我们突破了其它公司只提从一个包装的加工思路，提出了“一整套”服务理念，包括产前创意、3D 产品设计、产品模具设计及开发、注塑成型、涂装、丝网印刷、烫印、装配、产品质量后续跟踪分析等。

We broke through the processing ideas of other companies only mentioning a single package, and put forward a "complete set" of service concepts, including prenatal creativity, 3D product design, product mold design and development, injection molding, coating, screen printing, hot stamping, assembly, follow-up analysis of product quality, etc.

# Marketing Network

## 营销网络

宁波弗岚塑业有限公司（余姚市富兰德包装有限公司）集研发、生产、销售、服务于一体的专业化企业。公司凭借优异的产品质量及高效的服务，线上线下双布局模式，业务遍及全球100多个国家和地区，在国际舞台上赢得了广泛的知名度和影响力。



Ningbo Fly Plastic Industry Co., Ltd. (Yuyao Friend Packing Co., Ltd.) is a professional enterprise specialized in developing, producing, marketing and providing high-quality service. Our business covers more than 100 countries and regions around the world. In recent years, we have gained wide reputation and influence on the international stage.



FRIEND PACKING

Professional manufacturer of  
cosmetic packaging



真空瓶系列	P11-24
手扣式喷雾器	P25-30
乳液泵	P31-34
开关泵	P35-36
甲油泵	P37-38
泡沫泵	P39-39
电镀泵,金属泵	P40-45
手压式喷头	P46-50
香水分装瓶	P51-52
盖子	P53-56
膏霜罐系列	P57-64
持续喷雾瓶	P65-67
喷雾瓶系列	P68-70

## 产品目录

Always up-to-date,  
always available to you.  
Here you'll find everything on our products,  
solutions and service:  
[www.sprayer.com.cn](http://www.sprayer.com.cn)

Airless Bottle Series	P11-24
Trigger Sprayer	P25-30
Lotion Pump	P31-34
Left-Right Pump	P35-36
Nail pump	P37-38
Foam pump	P39-39
Special pump	P40-45
Fine Mist Sprayer	P46-50
Perfume bottles	P51-52
Various Cap	P53-56
Cream Jar	P57-64
Continuous spray bottle	P65-67
Spray bottle series	P68-70

# Catalogue

# 700

SERIES

## Airless Bottle Series

真空瓶系列



## FR701 Airless Bottle Series

真空瓶系列



### More combinations More options

配件可根据客户要求进行选配

Provide different parts of a variety of combination plan

#### HEAD OPTIONS

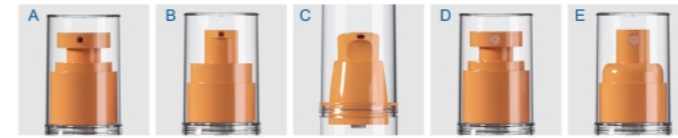

#### SPECIFICATION

Model	Capacity	Height(h)	Diameter(d)
FR701	15ml	95mm	33mm
	30ml	119mm	
	50ml	149mm	

#### PART MATERIAL

Cap	Actuator	Collar
AS/ABS	PP	PP
Bottle	Base	Type
AS	PP	SCREW ON



FR701

## FR702 Airless Bottle Series

真空瓶系列

### More combinations More options

配件可根据客户要求进行选配

Provide different parts of a variety of combination plan

#### HEAD OPTIONS

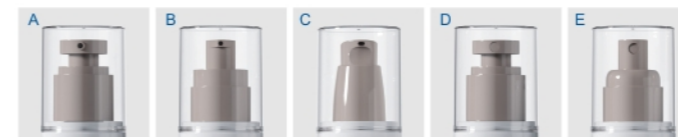

#### SPECIFICATION

Model	Capacity	Height(h)	Diameter(d)
FR702	80ml	153mm	41mm
	100ml	173mm	
	120ml	193mm	

#### PART MATERIAL

Cap	Actuator	Collar
AS/ABS	PP	PP
Bottle	Base	Type
AS	PP	SCREW ON



FR702

## FR703 Airless Bottle Series 真空瓶系列

### HEAD OPTIONS



### SPECIFICATION

Model	Capacity	Height(h)	Diameter(d)
FR703	5ml	82mm	19.8mm
	10ml	96mm	
	15ml	114mm	

### PART MATERIAL

Cap	Actuator	Collar	Bottle	Base	Type
AS/ABS	PP	ABS	AS	ABS	SCREW ON



FR703

## FR704 Airless Bottle Series 真空瓶系列

### HEAD OPTIONS



### SPECIFICATION

Model	Capacity	Height(h)	Diameter(d)
FR704	10ml	97mm	26mm
	15ml	114mm	
	20ml	127mm	
	30ml	162mm	

### PART MATERIAL

Cap	Actuator	Collar	Bottle	Base	Type
AS/ABS	PP	ABS	AS	ABS	SCREW ON



FR704

## FR705 Airless Bottle Series 真空瓶系列

### HEAD OPTIONS



### SPECIFICATION

Model	Capacity	Height(h)	Diameter(d)
FR705	10ml	97mm	26mm
	15ml	114mm	
	20ml	127mm	
	30ml	162mm	

### PART MATERIAL

Cap	Actuator	Collar	Bottle	Base	Type
AS/ABS	PP	ABS	AS	ABS	SCREW ON



FR705

## FR706 Airless Bottle Series 真空瓶系列



### HEAD OPTIONS



### SPECIFICATION

Model	Capacity	Height(h)	Diameter(d)
FR706	15ml	104mm	33mm
	30ml	127mm	
	50ml	157mm	

### PART MATERIAL

Cap	Actuator	Collar	Bottle	Base	Type
AS/ABS	PP	ABS	AS	ABS	SCREW ON



FR706

## FR707 Airless Bottle Series 真空瓶系列

### HEAD OPTIONS



### SPECIFICATION

Model	Capacity	Height(h)	Diameter(d)
FR707	15ml	104mm	33mm
	30ml	127mm	
	50ml	157mm	

### PART MATERIAL

Cap	Actuator	Collar	Bottle	Base	Type
AS/ABS	PP	ABS	AS	ABS	SCREW ON



FR707

## FR708 Airless Bottle Series 真空瓶系列

### HEAD OPTIONS



### SPECIFICATION

Model	Capacity	Height(h)	Diameter(d)
FR708	80ml	159mm	41mm
	100ml	179mm	
	120ml	199mm	

### PART MATERIAL

Cap	Actuator	Collar	Bottle	Base	Type
AS/ABS	PP	ABS	AS	ABS	SCREW ON



FR708



## FR709 Airless Bottle Series 真空瓶系列

### SPECIFICATION

Model	Capacity	Height(h)	Diameter(d)
FR709	10ml	91mm	26mm
	15ml	108mm	
	20ml	121mm	
	30ml	155mm	

### PART MATERIAL

Pump	Bottle	Base	Type
PP	AS	PP	SCREW ON



FR709

## FR710 Airless Bottle Series 真空瓶系列

Model	Capacity	Height(h)	Diameter(d)
FR710	15ml	90mm	33mm
	30ml	113mm	
	50ml	143mm	

### PART MATERIAL

Pump	Bottle	Base	Type
PP	AS	PP	SCREW ON



FR710

## FR711 Airless Bottle Series 真空瓶系列

Model	Capacity	Height(h)	Diameter(d)
FR711	80ml	147mm	41mm
	100ml	167mm	
	120ml	187mm	

### PART MATERIAL

Pump	Bottle	Base	Type
PP	AS	PP	SCREW ON



FR711

## FR713 Airless Bottle Series 真空瓶系列



### SPECIFICATION

Model	Capacity	Height(h)	Diameter(d)
FR713	30ml	128mm	41mm
	50ml	158mm	

### PART MATERIAL

Cap	Inside Bottle	Outside Bottle	Type
ABS+PP	PP	ABS	SCREW ON



FR713

## FR714 Airless Bottle Series 真空瓶系列

Model	Capacity	Height(h)	Diameter(d)
FR714	15ml	95mm	36mm
	30ml	123mm	
	50ml	161mm	

### PART MATERIAL

Cap	Inside Bottle	Outside Bottle	Type
ABS+PP	PP	ABS	SCREW ON



FR714

## FR715 Airless Bottle Series 真空瓶系列

Model	Capacity	Height(h)	Diameter(d)
FR715	15ml	95mm	36mm
	30ml	123mm	
	50ml	161mm	

### PART MATERIAL

Cap	Inside Bottle	Outside Bottle	Type
ABS+PP	PP	AS	SCREW ON



FR715

## FR801 Airless Bottle Series 真空瓶系列

### More combinations More options

配件可根据客户要求进行选择  
Provide different parts of a variety of combination plan

#### HEAD OPTIONS

#### SPRING OPTIONS



#### SPECIFICATION

Model	Capacity	Height(h)	Diameter(d)
FR801A	15ml	77mm	35mm
	30ml	99mm	
	50ml	124mm	

#### SPECIFICATION

Model	Capacity	Height(h)	Diameter(d)
FR801B	15ml	77mm	35mm
	30ml	99mm	
	50ml	124mm	

#### PART MATERIAL

Cap	Actuator	Collar	Bottle	Type
PP	PP	PP	PP	CLIP-ON



FR801A



FR801B

## FR802 Airless Bottle Series 真空瓶系列

#### SPECIFICATION

Model	Capacity	Height(h)	Diameter(d)
FR802	5ml	65mm	25mm
	10ml	77mm	
	15ml	92mm	

#### PART MATERIAL

Cap	Actuator	Collar	Bottle	Type
PP	PP	PP	PP	CLIP-ON



FR802

## FR803 Airless Bottle Series 真空瓶系列



#### SPECIFICATION

Model	Capacity	Height(h)	Diameter(d)
FR803A	15ml	84mm	29mm
	30ml	112mm	
	50ml	149mm	

#### PART MATERIAL

Cap	Pump	Bottle	Base	Type
PP	PP	PP	PP	CLIP-ON



FR803A

#### SPECIFICATION

Model	Capacity	Height(h)	Diameter(d)
FR803B	15ml	90mm	29mm
	30ml	119mm	
	50ml	156mm	

#### PART MATERIAL

Cap	Pump	Bottle	Base	Type
PP	PP	PP	PP	SCREW ON



FR803B

#### SPECIFICATION

Model	Capacity	Height(h)	Diameter(d)
FR803C	15ml	81mm	29mm
	30ml	110mm	
	50ml	148mm	

#### PART MATERIAL

Cap	Pump	Bottle	Base	Type
PP	PP	PP	PP	CLIP-ON



FR803C

## FR804 Airless Bottle Series 真空瓶系列

More combinations More options

配件可根据客户要求进行选择  
Provide different parts of a variety of combination plan

### HEAD OPTIONS



### SPECIFICATION

Model	Capacity	Height(h)	Diameter(d)
FR804	30ml	99mm	38mm
	50ml	120mm	
	75ml	148mm	
	100ml	176mm	

### PART MATERIAL

Cap	Pump	Bottle	Type
PP	PP	PP	SCREW ON



FR804A



FR804B

## FR805 Airless Bottle Series 真空瓶系列

### SPECIFICATION

Model	Capacity	Height(h)	Diameter(d)
FR805	15ml	80mm	31mm
	30ml	103mm	
	50ml	135mm	

### PART MATERIAL

Cap	Pump	Bottle	Base	Type
PP	PP	PP	PP	SCREW ON



FR805

## FR806 Airless Bottle Series 真空瓶系列

More combinations More options

配件可根据客户要求进行选择  
Provide different parts of a variety of combination plan

### HEAD OPTIONS



### SPECIFICATION

Model	Capacity	Height(h)	Diameter(d)
FR806	30ml	82mm	43mm
	50ml	99mm	
	80ml	120mm	
	100ml	138mm	
	120ml	153mm	
	150ml	184mm	

### PART MATERIAL

Cap	Actuator	Collar	Bottle	Type
PP	PP	PP	PP	CLIP-ON



FR806

## FR807 Airless Bottle Series 真空瓶系列

More combinations More options

配件可根据客户要求进行选择  
Provide different parts of a variety of combination plan

### HEAD OPTIONS



### SPECIFICATION

Model	Capacity	Height(h)	Diameter(d)
FR807	30ml	84mm	48mm
	50ml	97mm	
	80ml	114mm	
	100ml	130mm	
	150ml	163mm	
	200ml	196mm	

### PART MATERIAL

Cap	Actuator	Collar	Bottle	Type
PP	PP	PP	PP	CLIP-ON



FR807

## FR808 Airless Bottle Series 真空瓶系列

### SPECIFICATION

Model	Capacity	Height(h)	Diameter(d)
FR808	50ml	100mm	44*58mm
	100ml	130mm	

### PART MATERIAL

Cap	Actuator	Collar	Bottle	Type
PP	PP	PP	PP	CLIP-ON



FR808

## FR901 Airless Bottle Series 真空瓶系列

### More combinations More options

配件可根据客户要求进行选配  
Provide different parts of a variety of combination plan

### BOTTLE OPTIONS



### SPECIFICATION

Model	Capacity	Height(h)	Diameter(d)
FR901A	15ml	67mm	48mm
	30ml	77mm	
	50ml	92mm	
FR901B	15ml	62mm	48mm
	30ml	72mm	
	50ml	87mm	

### PART MATERIAL

Cap	Actuator	Collar	Bottle	Type
AS/ABS	PP	ABS	AS	SCREW ON



FR901

## FR902 Airless Bottle Series 真空瓶系列



### More combinations More options

配件可根据客户要求进行选配  
Provide different parts of a variety of combination plan

### BOTTLE OPTIONS



### SPECIFICATION

Model	Capacity	Height(h)	Diameter(d)
FR902	15ml	61mm	50mm
	30ml	73mm	
	50ml	75mm	58mm
	100ml	100mm	

### PART MATERIAL

Cap	Actuator	Collar
AS/GPPS	PP	ABS

Inside Bottle	Outside Bottle	Type
PP	AS/GPPS	SCREW ON



FR902

## FR903 Airless Bottle Series 真空瓶系列

### SPECIFICATION

Model	Capacity	Height(h)	Diameter(d)
FR903	30ml	85mm	67mm

### PART MATERIAL

Cap	Actuator	Collar	Bottle	Type
AS/ABS	PP	ABS	AS	SCREW ON



FR903

# FR1006 Airless Bottle Series

真空瓶系列

## More combinations More options

配件可根据客户要求进行选择  
Provide different parts of a variety of combination plan

### SPECIFICATION

Model	Capacity	Height(h)	Diameter(d)
FR1006	15ml	98mm	33mm
	30ml	122mm	
	50ml	155mm	

### PART MATERIAL

Cap	Pump	Bottle	Base	Type
AS	PP	PP	PP	SCREW ON



FR1006

# FR1008 Airless Bottle Series

真空瓶系列

## More combinations More options

配件可根据客户要求进行选择  
Provide different parts of a variety of combination plan

### BOTTLE OPTIONS

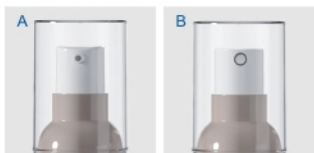

### SPECIFICATION

Model	Capacity	Height(h)	Diameter(d)
FR1008	15ml	106mm	31mm
	30ml	122mm	
	50ml	162mm	

### PART MATERIAL

Cap	Pump	Bottle	Base	Type
PP	PP	PP	PP	SCREW ON



FR1008

# FR1007 Airless Bottle Series

真空瓶系列



## More combinations More options

配件可根据客户要求进行选择  
Provide different parts of a variety of combination plan

### HEAD OPTIONS



### SPECIFICATION

Model	Capacity	Height(h)	Diameter(d)
FR1007A	30ml	107mm	41mm
	50ml	127mm	
	80ml	158mm	
	100ml	177mm	



FR1007A

### SPECIFICATION

Model	Capacity	Height(h)	Diameter(d)
FR1007B	30ml	106mm	41mm
	50ml	126mm	
	80ml	159mm	
	100ml	179mm	



FR1007B

### SPECIFICATION

Model	Capacity	Height(h)	Diameter(d)
FR1007C	30ml	105mm	41mm
	50ml	127mm	
	80ml	157mm	
	100ml	178mm	



FR1007C

### PART MATERIAL

Cap	Pump	Bottle	Base	Type
AS	PP	AS/PP	AS/PP	SCREW ON

# 100

SERIES

## Trigger Sprayer 手扣式喷雾器

### FEATURES:

- Different popular trigger sprayers available
- Dosage from 0.78CC to 1.2CC
- Made by auto-assembly and inspection guarantees quality and efficiency
- Five nozzles including spray/stream, spray/spray, foam etc.
- Three triggers including normal trigger, two fingers trigger and round trigger
- Various kinds of closures include 28/400, 28/410, 28/415 and ratchet closure
- Both soft tube and rigid tube for choice
- Quick priming

### APPLICATIONS:

- Household chemicals
- Automotive care products
- Gardening



# 101 Trigger Sprayer 手扣式喷雾器



DISCHARGE RATE  
0.75 ± 0.10ML/T



### More combinations More options

配件可根据客户要求进行选配  
Provide different parts of a variety of combination plan

#### CLOSURE OPTIONS

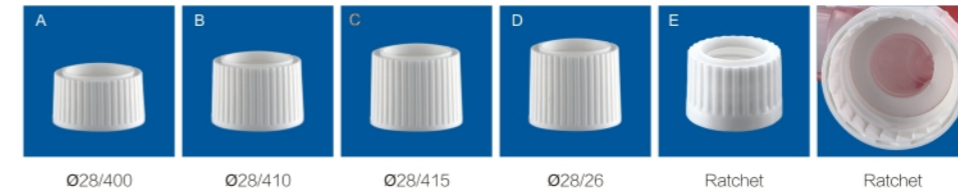

#### TRIGGER OPTIONS

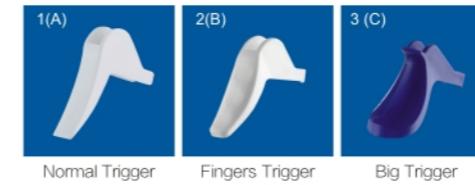

#### NOZZLE OPTIONS

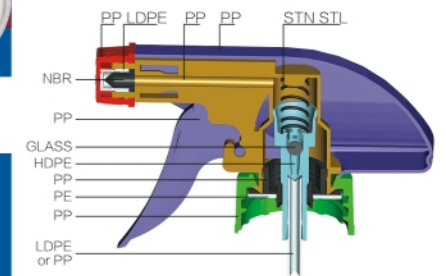
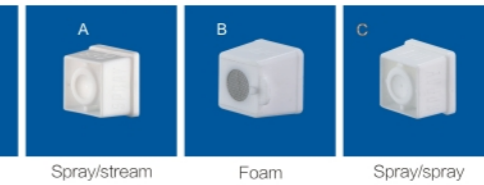

PRODUCTION	QYT/CNT	DIMENSION(cm)
H-1/H-2/H-3/H-4	500PCS	57 × 32 × 39
H-5/H-6/H-7/H-8	500PCS	57 × 32 × 42
H-9	500PCS	57 × 38 × 40

# 102 Trigger Sprayer

手扣式喷雾器

DISCHARGE RATE  
1.40 ± 0.10ML/T

More combinations More options

配件可根据客户要求进行选配  
Provide different parts of a variety of combination plan



FS102-G1



FS102-G2



FS102-G3



FS102-G4

CLOSURE OPTIONS

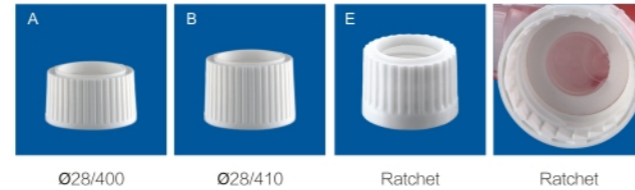

NOZZLE OPTIONS

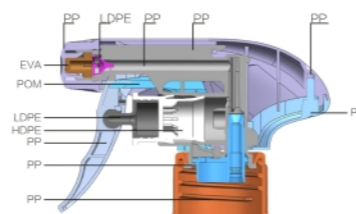

PRODUCTION	QYT/CNT	DIMENSION(cm)
G1	500PCS	57 × 38 × 40
G2/G3/G4	500PCS	57 × 32 × 42

# 103 Trigger Sprayer

手扣式喷雾器

DISCHARGE RATE  
1.40 ± 0.10ML/T



FS103-F1

Ø28/410, Ø28/410

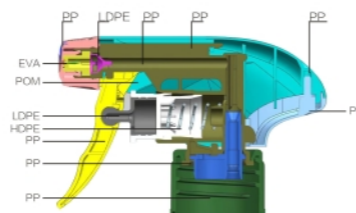

PRODUCTION	QYT/CNT	DIMENSION(cm)
F1	500PCS	57 × 32 × 40

# 104A Trigger Sprayer

手扣式喷雾器



DISCHARGE RATE  
0.20 ± 0.10ML/T



FS104A-1

Ø24/410, Ø28/410(smooth/ribbed)



FS104A-2

Ø24/410, Ø28/410(smooth/ribbed)



FS104A-3

Ø24/410, Ø28/410(smooth/ribbed)



FS104A-4

Ø24/410, Ø28/410(smooth/ribbed)

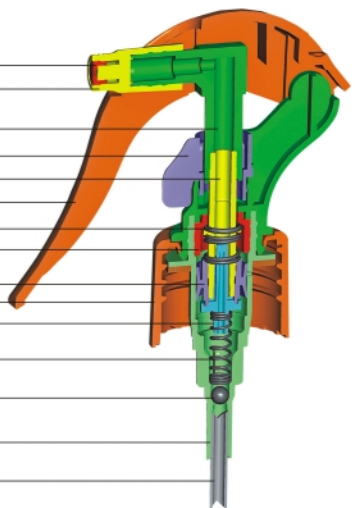

FS104A-5

Ø24/410, Ø28/410(smooth/ribbed)

PRODUCTION	QYT/CNT	DIMENSION(cm)	QYT/CNT	DIMENSION(cm)
FS104A 24/410	500PCS	43 × 32 × 39	1000PCS	57 × 38 × 40
FS104A 28/410	500PCS	43 × 32 × 41	1000PCS	57 × 38 × 44

# 104B Trigger Sprayer

手扣式喷雾器

DISCHARGE RATE  
0.30 ± 0.05ML/T

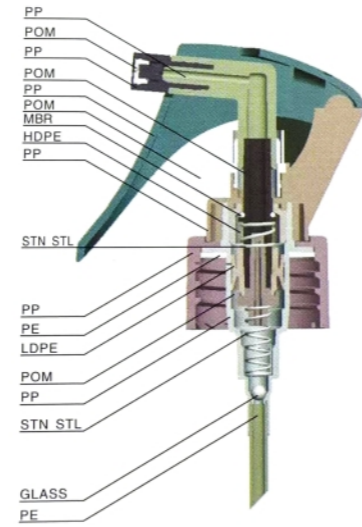

**FS104B**

Ø20/410, Ø24/410, Ø28/410(smooth/ribbed)

PRODUCTION	QYT/CNT	DIMENSION(cm)
FS104B	500PCS	43 × 32 × 39

# 105 Trigger Sprayer

手扣式喷雾器

DISCHARGE RATE  
0.50 ± 0.05ML/T

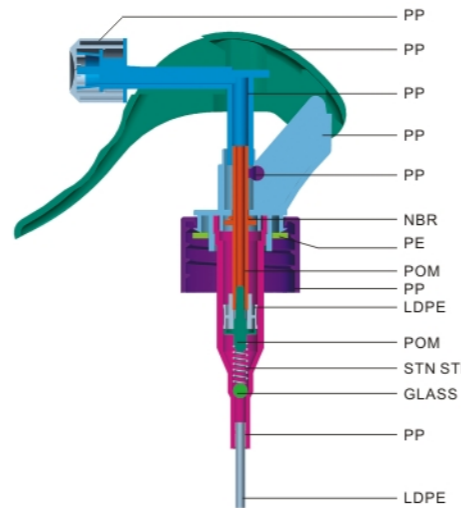

**FS105-E5**

Ø24/410, Ø28/410(smooth/ribbed)

PRODUCTION	QYT/CNT	DIMENSION(cm)
FS105-E5	500PCS	57 × 32 × 40

# 106A/C Trigger Sprayer

手扣式喷雾器



DISCHARGE RATE  
0.90 ± 0.10ML/T



**FS106A**

Ø28/400, Ø28/410



**FS106C**

Ø28/400, Ø28/410

### More combinations More options

配件可根据客户要求进行选择  
Provide different parts of a variety of combination plan

#### NOZZLE OPTION

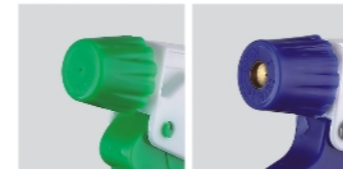

#### TRIGGER OPTION



#### INSERT OPTION



PRODUCTION	QYT/CNT	DIMENSION(cm)
FS106A	500PCS	55 × 35 × 40
FS106C	500PCS	55 × 35 × 40



## 106B Trigger Sprayer 手扣式喷雾器

DISCHARGE RATE  
0.90 ± 0.10ML/T



PRODUCTION	QYT/CNT	DIMENSION(cm)
FS106B	500PCS	57 × 33 × 40

**FS106B**  
Ø28/400, Ø28/410

## 106D Trigger Sprayer 手扣式喷雾器

DISCHARGE RATE  
1.10 ± 0.10ML/T



PRODUCTION	QYT/CNT	DIMENSION(cm)
FS106D	500PCS	56 × 36 × 46

**FS106D**  
Ø28/400, Ø28/410

## 106E Trigger Sprayer 手扣式喷雾器

DISCHARGE RATE  
0.90 ± 0.10ML/T



PRODUCTION	QYT/CNT	DIMENSION(cm)
FS106E	500PCS	57 × 33 × 40

**FS106E**  
Ø28/400, Ø28/410

## 107 Trigger Sprayer 手扣式喷雾器

DISCHARGE RATE  
0.30 ± 0.05ML/T



**FS107-1**  
Ø24/410, Ø28/410



**FS107-2**  
Ø24/410, Ø28/410

PRODUCTION	QYT/CNT	DIMENSION(cm)
FS107	500PCS	57 × 32.5 × 39

## 108 Trigger Sprayer 手扣式喷雾器

DISCHARGE RATE  
0.90 ± 0.10ML/T



**FS108**  
Ø28/400, Ø28/410

PRODUCTION	QYT/CNT	DIMENSION(cm)
FS108	500PCS	57 × 39 × 42

# 200

SERIES

## Lotion Pump 乳液泵

### FEATURES:

- Different dosage from 1.2ml to 5ml
- Ergonomic design in actuator and shape provides comfortable use feeling
- Popular inside&outside spring suructure meets customer' s different requirements in different fields
- Left-Right and Screw down lock system
- Different closure options and shape processing procedure
- Special structure design principle makes pump more safe and wide using
- Head Clockwise and Anti-clockwise for choose

### APPLICATIONS:

- Body lotion
- Cleansing Water
- Liquid soap
- Sun oil
- Hair care products
- Washing liquid
- Facial cream



201 series    202 series    203 series    204A series    204B series    205 series

# 201

Screw pump  
螺纹泵



DISCHARGE RATE  
1.80 ± 0.20ML/T



FS201-1

FS201-AUL-1

### More combinations More options

配件可根据客户要求进行选配  
Provide different parts of a variety of combination plan

#### CLOSURE OPTIONS



Ø24/410 smooth    Ø24/410 ribbed    Ø28/400 ribbed    Ø28/410 smooth    Ø28/410 ribbed    Ø28/415 ribbed    Ø28/412 PCO

#### TECHNOLOGICAL OPTIONS



光面 Smooth    莱丝 Ribbed



氧化铝 Alu.    UV

#### ACTUATOR OPTIONS



FS201-2    FS201-3    FS201-5    FS201-6    FS201-8    FS201-9



FS201-10    FS201-11    FS201-12    FS201-13    FS201-14    FS201-double closure

#### PRODUCTION

	QYT/CNT	DIMENSION(cm)
FS201-8/FS201-9/FS201-10/FS201-11/FS201-13/FS201-14	1000PCS	57 × 38 × 42
FS201-1/FS201-2/FS201-3/FS201-4/FS201-5/FS201-6/FS201-7/FS201-12	1000PCS	57 × 32 × 40

# 202 Simple sprayer/lotion pump

简易喷雾乳液泵

DISCHARGE RATE  
1.80 ± 0.20ML/T



FS202

### More combinations More options

配件可根据客户要求进行选配  
Provide different parts of a variety of combination plan

#### ACTUATOR OPTION



sprayer pump

lotion pump

#### CLOSURE OPTIONS



Ø24/410 smooth    Ø24/410 ribbed    Ø28/400 ribbed    Ø28/410 smooth    Ø28/410 ribbed    Ø28/415 ribbed

#### TECHNOLOGICAL OPTIONS



光面 Smooth    莱丝 Ribbed    氧化铝 Alu.    UV

PRODUCTION	QYT/CNT	DIMENSION(cm)
FS202	500PCS	57 × 38 × 40

# 203-1 2CC sprayer pump single hole three holes

2CC喷雾泵 单孔三孔

DISCHARGE RATE  
2.00 ± 0.20ML/T



FS203-1

### More combinations More options

配件可根据客户要求进行选配  
Provide different parts of a variety of combination plan

#### ACTUATOR OPTION

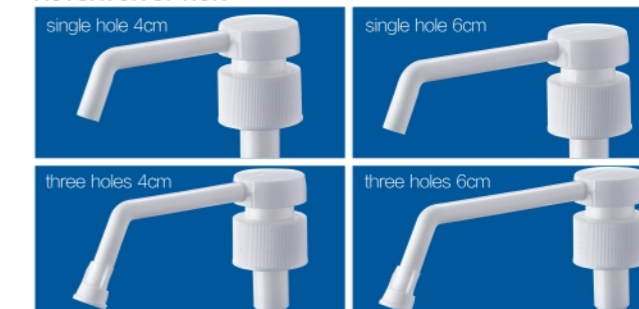

#### CLOSURE OPTIONS



Ø24/410 smooth    Ø24/410 ribbed    Ø28/410 smooth    Ø28/410 ribbed

PRODUCTION	QYT/CNT	DIMENSION(cm)
FS203-1	500PCS	57 × 32 × 40

# 203-2 4CC sprayer pump single hole three holes

4CC喷雾泵 单孔三孔

DISCHARGE RATE  
4.00 ± 0.20ML/T



FS203-2

### More combinations More options

配件可根据客户要求进行选配  
Provide different parts of a variety of combination plan

#### ACTUATOR OPTION



#### CLOSURE OPTIONS



Ø32/410 smooth    Ø32/410 ribbed    Ø38/410 smooth    Ø38/410 ribbed

PRODUCTION	QYT/CNT	DIMENSION(cm)
FS203-2	500PCS	57 × 32 × 40

# 204A Spring Outside Srew Pump 2.5CC

外置螺纹泵2.5CC

DISCHARGE RATE  
2.50 ± 0.20ML/T



**FS204A**  
外置螺纹泵2.5CC

### More combinations More options

配件可根据客户要求进行选配  
Provide different parts of a variety of combination plan

#### ACTUATOR OPTIONS



FS204A-1 FS204A-2 FS204A-3 FS204A-4

#### CLOSURE OPTIONS



A Ø24/410 smooth B Ø24/410 ribbed E Ø28/410 smooth F Ø28/410 ribbed

#### TECHNOLOGICAL OPTIONS



光面 Smooth 莱丝 Ribbed 氧化铝 Alu. UV

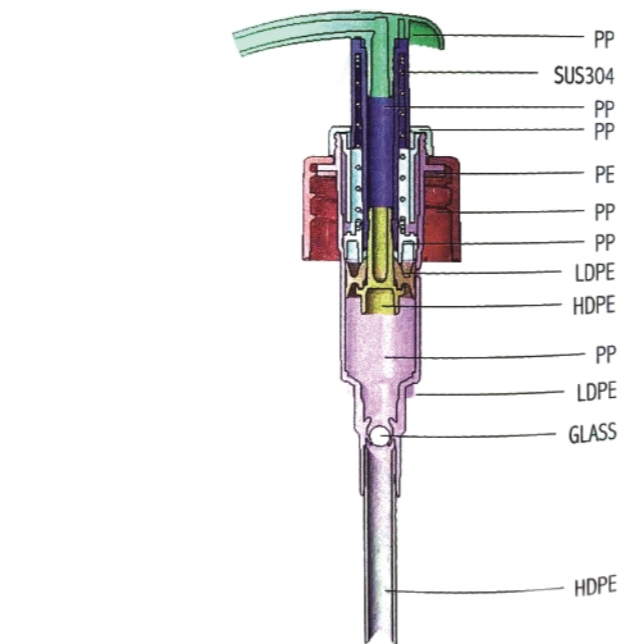

PRODUCTION	QYT/CNT	DIMENSION(cm)
FS204A	1000PCS	60 × 40 × 38

# 204B Spring Outside Srew Pump 4.5CC

外置螺纹泵4.5CC

DISCHARGE RATE  
4.50 ± 0.10ML/T



**FS204B**  
外置螺纹泵4.5CC

### More combinations More options

配件可根据客户要求进行选配  
Provide different parts of a variety of combination plan

#### ACTUATOR OPTIONS



FS204B-1 FS204B-2

#### CLOSURE OPTIONS



Ø28/410 smooth Ø28/410 ribbed Ø32/410 smooth Ø32/410 ribbed

#### TECHNOLOGICAL OPTIONS



光面 Smooth 莱丝 Ribbed 氧化铝 Alu. UV

PRODUCTION	QYT/CNT	DIMENSION(cm)
FS204B	500PCS	57 × 32 × 40

# 205 Srew Pump 4.0CC

螺纹泵4.0CC

DISCHARGE RATE  
4.00 ± 0.10ML/T



Ø32/410 Ribbed Ø28/410, Ø32/410 Smooth/Ribbed Ø28/410, Ø32/410 Smooth/Ribbed

PRODUCTION	QYT/CNT	DIMENSION(cm)
FS205	500PCS	57 × 32 × 40



Ø32/410 Ribbed Ø38/410 Ribbed Ø38/410 Special Ribbed



Ø24/410 double layer Ø28/410 double layer Ø32/410 double layer

# 300

SERIES

Left-Right pump

开关泵



## 301 Left-Right pump

开关泵



DISCHARGE RATE  
2.00 ± 0.10ML/T



### More combinations More options

配件可根据客户要求进行选配  
Provide different parts of a variety of combination plan

#### ACTUATOR OPTIONS



#### CLOSURE OPTIONS



#### TECHNOLOGICAL OPTIONS

PRODUCTION	QYT/CNT	DIMENSION(cm)
FS301-2/FS301-5/FS301-6/FS301-9	1000PCS	57 × 38 × 42
FS301-1/FS301-3/FS301-4/FS301-7/FS301-8/FS301-10	1000PCS	57 × 38 × 40

# 302 Spring Out's pump

外置开关泵

DISCHARGE RATE  
2.50 ± 0.10ML/T

More combinations More options

配件可根据客户要求进行选配  
Provide different parts of a variety of combination plan

ACTUATOR OPTIONS



CLOSURE OPTIONS



Ø24/410 smooth    Ø24/410 ribbed    Ø28/410 smooth    Ø28/410 ribbed



Ø28/400 ribbed

TECHNOLOGICAL OPTIONS



光面 Smooth    莱丝 Ribbed    氧化铝 Alu.    UV

PRODUCTION	QYT/CNT	DIMENSION(cm)
FS302	500PCS	57 × 38 × 40

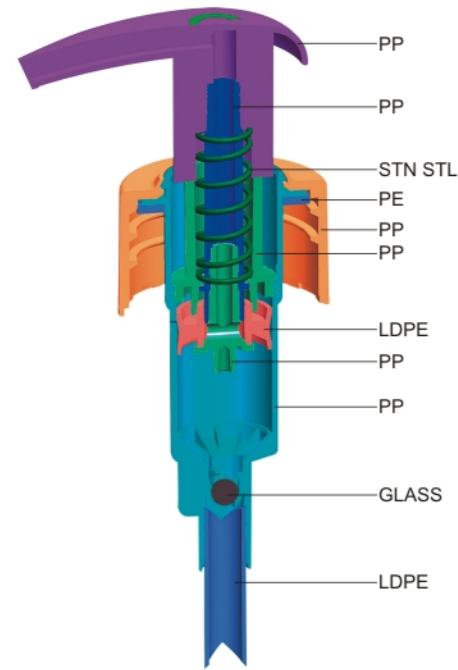

Ø24/410 smooth    Ø24/410 ribbed    Ø28/400 ribbed    Ø28/410 smooth    Ø28/410 ribbed

# 303 Clip pump

夹子泵

DISCHARGE RATE  
1.00 ± 0.10ML/T



FS303

Ø20/410, Ø24/410, Ø28/400, Ø28/410

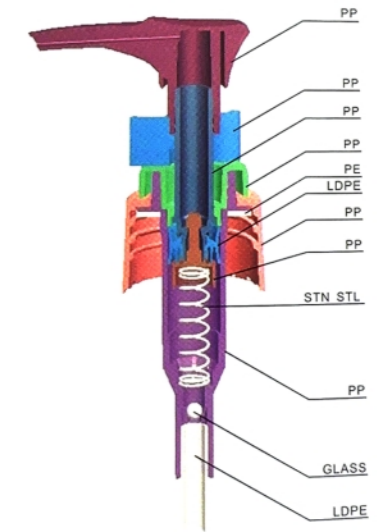

# 304 Clip pump

卸妆油泵

DISCHARGE RATE  
1.00 ± 0.10ML/T



FS304-1

Ø20/410, Ø24/410, Ø28/410

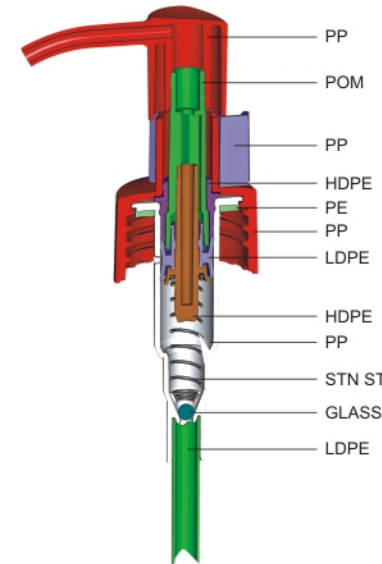

FS304-2

Ø20/410, Ø24/410, Ø28/410

PRODUCTION	QYT/CNT	DIMENSION(cm)
20/410	2000PCS	57 × 32 × 37
24/410	1250PCS	50 × 38 × 40
28/410	1000PCS	45 × 39 × 50

# 305 Nail pump

指甲油泵

DISCHARGE RATE  
0.55 ± 0.05ML/T

Inner Spring 内置弹簧



**FS305-1**  
Ø24/410, Ø28/410

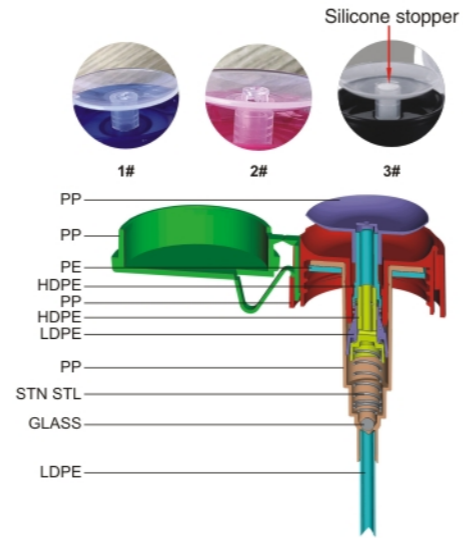

**FS305-2**  
Ø24/410, Ø28/410, Ø33/410



**FS305-3**  
Ø28/410

Outer Spring 外置弹簧



**FS305-4**  
Ø24/410

**FS305-5**  
Ø33/410

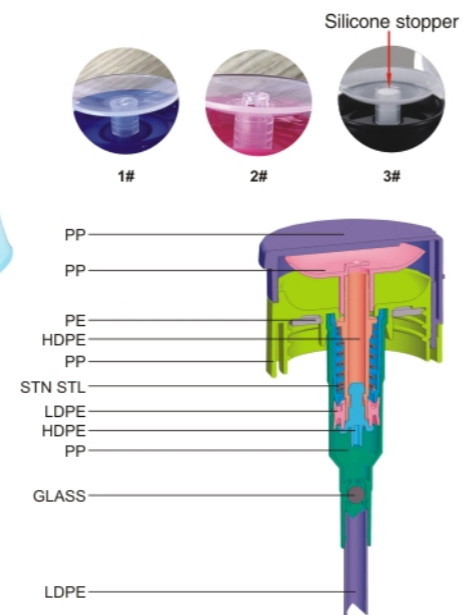

# 305 Nail varnish bottle

指甲油瓶



PET-100ml    PET-150ml    PET-180ml    PET-200ml    PET-240ml    PET-400ml    PP-250ml

**FS305-A01~FS305-A07**



PP-120ml    PP-150ml    PP-150ml    PP-150ml    PP-180ml    PP-180ml    PP-200ml    PP-200ml

**FS305-B01~FS305-B08**



PE-50ml    PE-80ml    PE-100ml    PE-120ml    PE-180ml    PE-190ml    PE-200ml    PE-220ml

**FS305-C01~FS305-C08**

DISCHARGE RATE  
 $0.35 \pm 0.05 \text{ML/T}$



**FS306-A1**  
Ø28/400  
三角嘴

**FS306-A2**  
Ø28/400  
扁平嘴 半圆罩

DISCHARGE RATE  
 $0.40 \pm 0.06 \text{ML/T}$



**FS306-B1**  
Ø30/410  
夹子泵

**FS306-B2**  
Ø30/410  
三角嘴

**FS306-B3**  
Ø30/410  
扁平嘴

**FS306-B4**  
Ø30/410  
梳子泵

**FS306-B5**  
Ø30/410  
硅胶刷

DISCHARGE RATE  
 $0.80 \pm 0.12 \text{ML/T}$



**FS306-C1**  
Ø40/400 夹子泵

**FS306-C2**  
Ø40/410 锁头泵

**FS306-C3**  
Ø40/410 高口泵

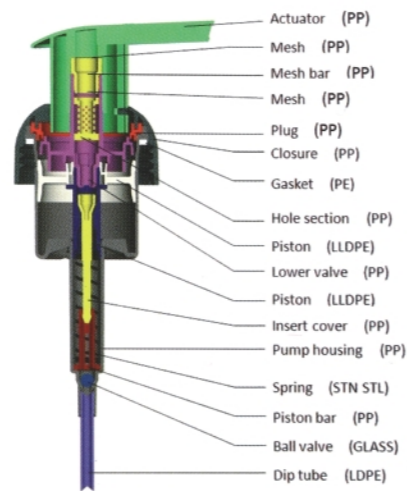

DISCHARGE RATE  
 $0.80 \pm 0.12 \text{ML/T}$



**FS306-D1**  
Ø42/410 夹子泵

**FS306-D2**  
Ø42/410 三角嘴 半圆罩

**FS306-D3**  
Ø42/410 扁平嘴 防尘罩

**FS306-D4**  
Ø42/410 硅胶刷

**FS306-D5**  
Ø42/410 长杆泵



**FS306-E01~FS306-E06**



**FS306-F01~FS306-F06**



**FS306-G01~FS306-G04**





**FS307-1**

Ø24/410, Ø28/410



**FS307-2**

Ø24/410, Ø28/410



**FS307-3**

Ø24/410, Ø28/410

**FS307-4**

Ø24/410, Ø28/410

# 400

SERIES

## Fine Mist Sprayer 手压式喷头

### FEATURES:

- Wide range of closure options
- Creating use-protect cap design
- Full auto-assembly and inspecting machine guarantee efficiency and quality
- Customer metal shell and UV or Artistic decoration available
- Upside-Down design sprayer

### APPLICATIONS:

- Skin care products such as Moisture liquid
- Cleaning products
- Medical treatment spray
- For hair products
- Sun care products
- Kitchen use



# 401-A Mist pump 微喷

DISCHARGE RATE  
0.12 ± 0.02ML/T

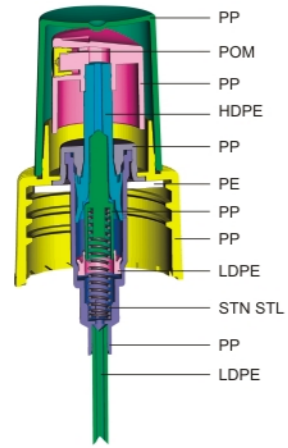

## More combinations More options

配件可根据客户要求进行选配  
Provide different parts of a variety of combination plan

### CAP OPTIONS

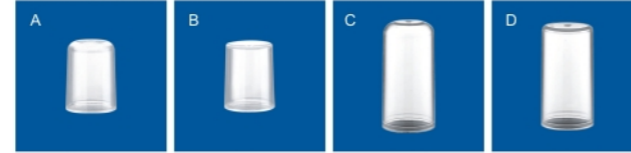

Round Flat Full Full

### TECHNOLOGICAL OPTIONS



光面 Smooth 莱丝 Ribbed 氧化铝 Alu. UV



# 402A Cream pump 粉泵

DISCHARGE RATE  
0.25 ± 0.02ML/T

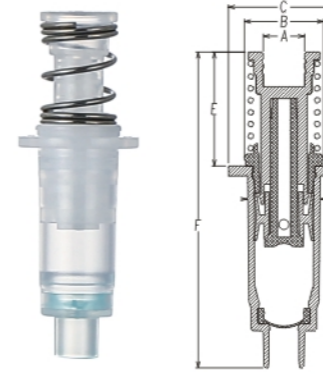

## More combinations More options

配件可根据客户要求进行选配  
Provide different parts of a variety of combination plan

### ACTUATOR OPTIONS



E(Only Fit Full Cap) F (Sprayer Nozzle)

### CLOSURE OPTIONS



Ø18/410, Ø20/410, Ø24/410 Ø18/410, Ø20/410, Ø24/410 Ø24/410 Ø20/410

### CAP OPTIONS



Half Cap Full Cap Full Cap

### TECHNOLOGICAL OPTIONS



光面 Smooth 莱丝 Ribbed 氧化铝 Alu. UV



### FS402-A

Ø18/410, Ø20/410, Ø24/410 smooth/ribbed



### FS402-B

Ø20/410 smooth



### FS402-C

Ø24/410 smooth

# 402D Cream pump 粉泵

DISCHARGE RATE  
0.50 ± 0.02ML/T



**FS402D**  
Ø24/410 smooth

More combinations More options

配件可根据客户要求进行选配  
Provide different parts of a variety of combination plan

ACTUATOR OPTIONS



# 402E Cream pump 粉泵

DISCHARGE RATE  
0.25 ± 0.02ML/T



**FS402E-1**  
Ø18/410 smooth



**FS402E-2**  
Ø20/410 ribbed

# 404 Nasal Spray/Oral Spray 鼻喷/口喷

DISCHARGE RATE  
0.12 ± 0.02ML/T



**FS404-1**  
Ø18/410, Ø20/410 ribbed

**FS404-2**  
Ø18/410, Ø20/410, Ø24/410 ribbed

DISCHARGE RATE  
0.12 ± 0.02ML/T



Ø20/410, Ø24/410 ribbed

Ø20/410, Ø24/410 smooth

Ø20/410, Ø24/410 aluminum

**FS404-3**



Ø30/410 ratchet

Ø30/410 ribbed

Ø30/410 smooth

**FS404-4**

# 405 Metal buckle

金属卡扣

DISCHARGE RATE  
0.06 ± 0.01ML/T



Ø13/400    Ø15/400    Ø18/400    Ø20/400

FS405-A1

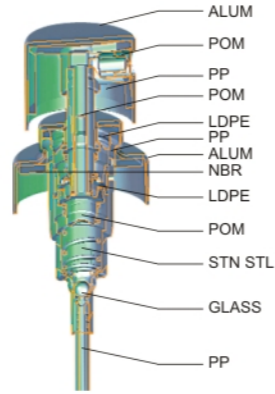

Ø13/400    Ø15/400    Ø18/400    Ø20/400

FS405-A2



Ø18/410    Ø20/410    Ø24/410

FS405-A3

# 406 Metal buckle

金属卡扣

DISCHARGE RATE  
0.12 ± 0.02ML/T



Ø15/400    Ø18/400    Ø20/400

FS406-A1

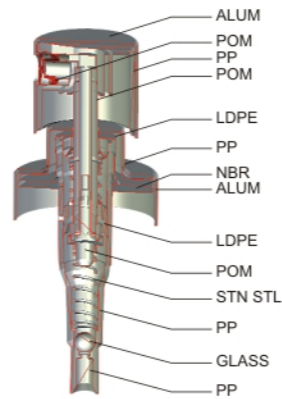

Ø15/400    Ø18/400    Ø20/400

FS406-A2



Ø18/410    Ø20/410    Ø24/410

FS406-A3

# 500

SERIES

Perfume Bottles  
香水分装瓶



More combinations More options

颜色可根据客户要求进行选配  
Colors different parts of a variety of combination plan

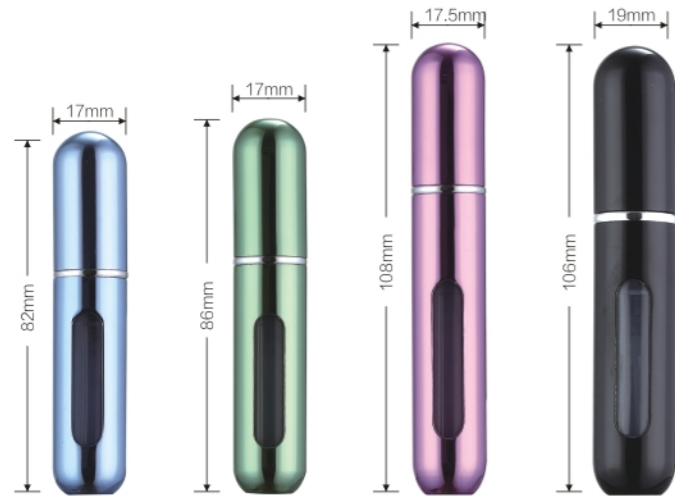

**FS501-1**

3ml, 5ml, 8ml, 10ml Gloss Style



More combinations More options

颜色可根据客户要求进行选配  
Colors different parts of a variety of combination plan

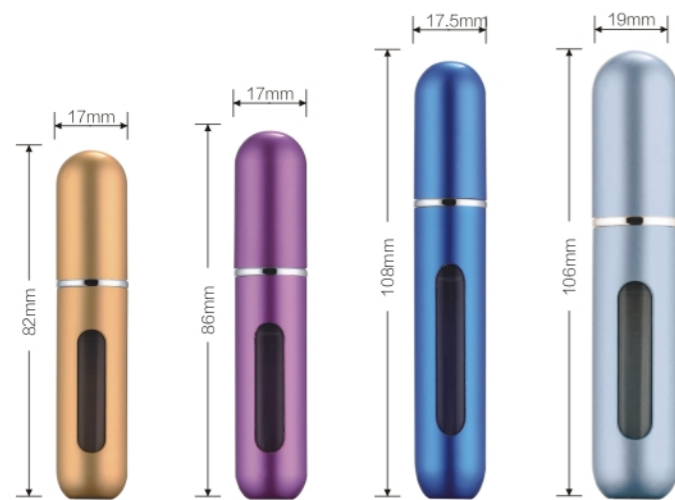

**FS501-2**

3ml, 5ml, 8ml, 10ml Frosted Style



**FS501-3**



**FS501-4**



**FS501-5**

**FS501-6**



10ml      12ml      15ml      20ml      20ml

**FS501-7**



30ml



**FS501-8**



3ml      5ml      2ml      3ml      5ml      1ml      5ml      8ml      10ml      15ml  
smooth

**FS501-9**      **FS501-10**      **FS501-11**      **FS501-12**



5ml      8ml smooth      10ml      5ml      8ml ribbed      10ml      15ml      10ml      10ml

**FS501-13**      **FS501-14**      **FS501-15**



5ml      8ml      10ml ribbed      15ml      18ml      15ml      18ml      20ml smooth      30ml      10ml      10ml

**FS501-16**      **FS501-17**



FS502A



FS502B

FS502C

FS502D

FS502E



FS502F

FS502G

FS502H



FS502I

FS502J



FS502K

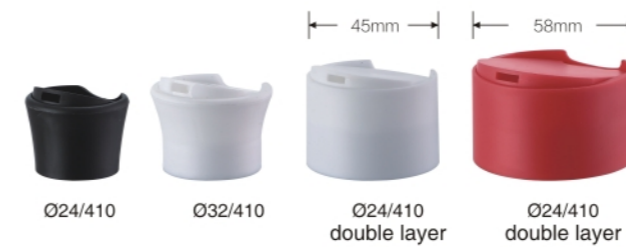

FS502L



FS502L-2



FS502M



FS502N



FS502O



FS502P



15g(material:PP)  
38\*18\*75mm  
**FS503A**

PRODUCTION	QYT/CNT	DIMENSION(cm)
FS503A(bottle)	1500PCS	55 × 39 × 36
FS503A(Cap)	1500PCS	55 × 39 × 36



15g 29\*70mm    30g 35\*78mm    50g 48\*85mm    75g 48\*103mm  
(material:GPPS)  
**FS503B**

PRODUCTION	QYT/CNT	DIMENSION(cm)
FS503B(15g)(bottle)	600PCS	47 × 27 × 31
FS503B(15g)(base)	4200PCS	47 × 27 × 31
FS503B(30g)(bottle)	480PCS	45 × 38 × 34
FS503B(30g)(base)	3600PCS	45 × 38 × 34
FS503B(50g)(bottle)	300PCS	45 × 32 × 44
FS503B(50g)(base)	1680PCS	45 × 32 × 44
FS503B(75g)(bottle)	240PCS	45 × 32 × 44
FS503B(75g)(base)	1680PCS	45 × 32 × 44



100g    200g    300g  
(material:ABS)  
**FS503C**

PRODUCTION	QYT/CNT	DIMENSION(cm)
FS503C(100g)	300PCS	57 × 45 × 36
FS503C(200g)	150PCS	57 × 45 × 36
FS503C(300g)	100PCS	57 × 45 × 36



100g    200g    300g    500g  
(material:ABS)  
**FS503D**

PRODUCTION	QYT/CNT	DIMENSION(cm)
FS503C(100g)	300PCS	57 × 45 × 36
FS503C(200g)	150PCS	57 × 45 × 36
FS503C(300g)	100PCS	57 × 45 × 36
FS503C(500g)	72PCS	57 × 38 × 40



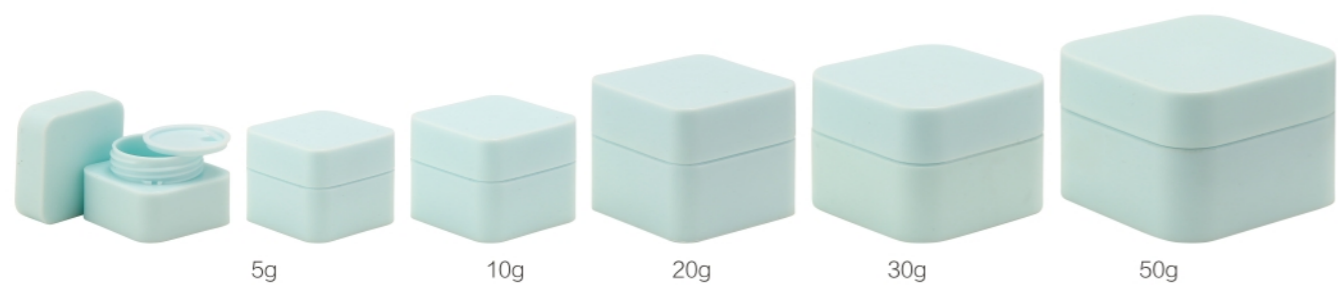

(material:PP)  
**FS503E**



**FS503J**



**FS503K**



**FS503L**



**FS503M**



**FS503N**



**FS503O**

**FS503P**

**FS503Q**

# 600

SERIES

## Continuous Spray Bottle

持续喷雾瓶



## 601B Continuous spray bottle

持续性喷雾瓶



### PRINT AREA

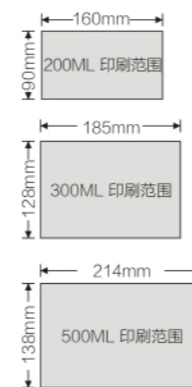

### FS601B

200ml 300ml 500ml

### More combinations More options

配件可根据客户要求进行选配  
Provide different parts of a variety of combination plan



Nozzle details Bottle neck details Lock Packing Design

### BOTTLE DESIGN

Conical Bottle  
200ml  
300ml  
500ml



Straight Bottle  
200ml  
300ml



PRODUCTION	DIMENSION(cm)	QYT/CNT
200ML	63 × 38.5 × 43	100PCS
300ML	63 × 38.5 × 50	with small boxes 140PCS
500ML	69 × 39 × 58	without small boxes

## 602B Oil spray bottle

喷油瓶

Plastic Oil spray bottle

### PRINT AREA

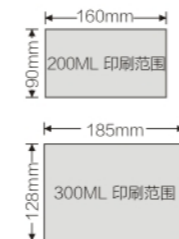

### FS602B

200ml 300ml



Nozzle details Bottle neck details Lock Packing Design

### BOTTLE DESIGN

Conical Bottle  
200ml  
300ml



Straight Bottle  
200ml  
300ml



PRODUCTION	DIMENSION(cm)	QYT/CNT
200ML	63 × 38.5 × 43	100PCS
300ML	63 × 38.5 × 50	with small boxes 140PCS
		nowith small boxes

Glass Oil spray bottle



### FS602B

200ml 300ml



Nozzle details Bottle neck details Lock Packing Design

### BOTTLE DESIGN

Glass Bottle  
200ml  
300ml



PRODUCTION	DIMENSION(cm)	QYT/CNT
200ML	41 × 35.5 × 50	50PCS
300ML	41 × 35.5 × 60	

# 603B Oil spray bottle

喷油瓶

Glass Oil spray bottle



**FS603B**  
470ml

## More combinations More options

配件可根据客户要求进行选配  
Provide different parts of a variety of combination plan



Nozzle details Nozzle details Bottle neck details

Functional display



# 603C Oil spray bottle

喷油瓶

Glass Oil spray bottle



**FS603C**  
550ml

## More combinations More options

配件可根据客户要求进行选配  
Provide different parts of a variety of combination plan



Nozzle details Nozzle details Bottle neck details Packing Design

Functional display



# 603D Oil spray bottle

喷油瓶

Glass Oil spray bottle



**FS603D**  
500ml

## More combinations More options

配件可根据客户要求进行选配  
Provide different parts of a variety of combination plan



Nozzle details Nozzle details Bottle neck details Packing Design

Functional display

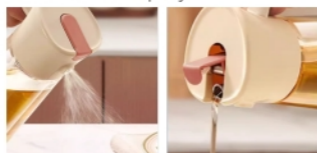

# 701 Spray bottle series

喷雾瓶系列



Ø28/500ml 300ml 500ml 500ml 500ml

**FS701X**



500ml 500ml 500ml 750ml 500ml 1000ml

**FS701Y**

**702** Spray bottle series  
喷雾瓶系列



FS702-01~FS702-07



FS702-08~FS702-14



FS702-15~FS702-20

**702** Spray bottle series  
喷雾瓶系列



FS702B

FS702C-01~FS702C-03



FS702C-04~FS702C-09



FS702C-10~FS702C-14